

Varenummer: 0108062
 Beskrivelse: Seeger låsering JK 45 DIN 984

Mål

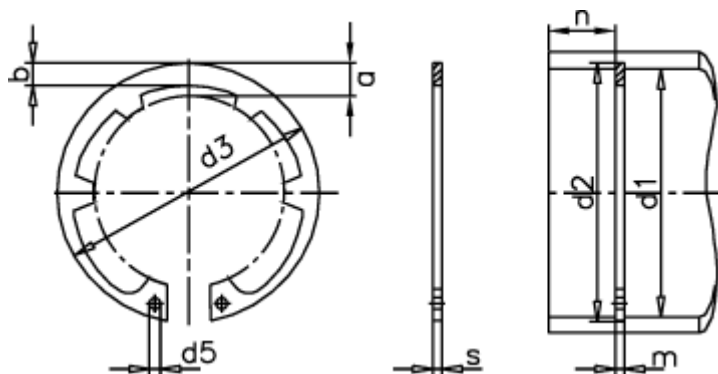

a max	= 7.2	d5 min	= 2.5	s	= 1.75
AN mm ²	= 181.0	FN kN	= 30.2	t	= 1.25
Antal takker	= 6	FRg kN	= 8.2	Tang	= ZGJ-3
b	= 4.3	FR kN	= 43.1	tol	= -0.06
Betegnelse	= JK 45	g	= 2.0	tol	= +0,90-0,39
d1	= 45	K kN-mm	= 78.1	tol	= +0,25
d2	= 47.5	m min	= 1.85	vægt kg/1000	= 6.60
d3	= 48.5	Nominal træk	= 3.8		